



Magic I/OTM
Input/Output
Adapter for the
IBM PC/XT/AT

OWNER'S MANUAL AND REFERENCE GUIDE
EV-170 and EV-170A
(VERSION 4.0)

EVER for EXcellence

MAN-00054-40

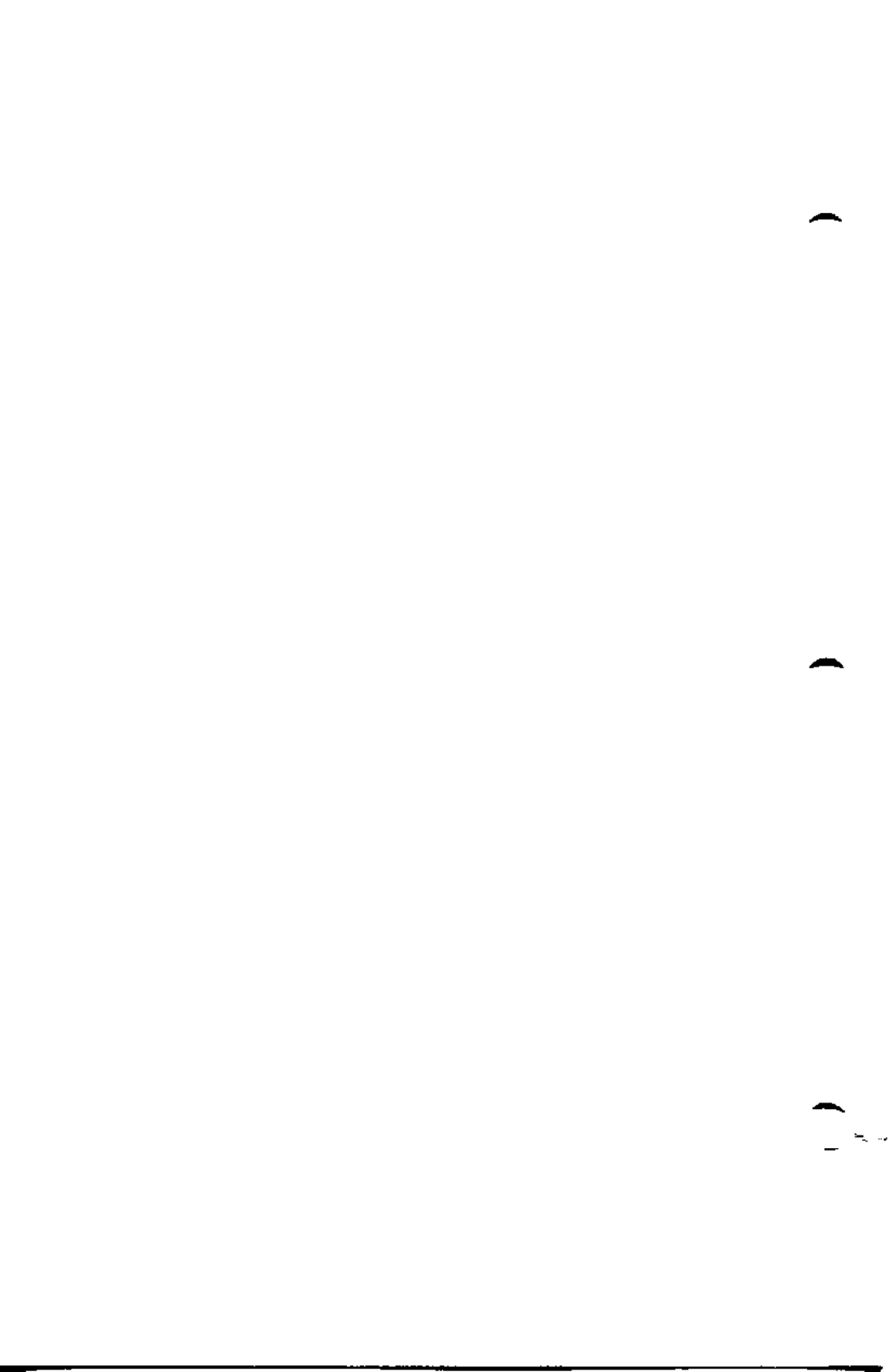

Magic I/OTM
Input/Output
Adapter for the
IBM PC/XT/AT

OWNER'S MANUAL AND REFERENCE GUIDE
EV-170 and EV-170A
(VERSION 4.0)

EVEREX SYSTEMS, INC.
48431 MILMONT DRIVE
FREMONT, CA 94538

Notice

Everex Systems, Inc reserves the right to make improvements in the product described in this manual at any time and without notice.

The IBM PC, XT, AT and Portable are trademarks of International Business Machines Corporation.

MS DOS is a trademark of Microsoft Corporation.

DISCLAIMER: While we do our best to avoid such a situation, Everex Systems will not be responsible for any loss of information resulting from the use of the product.

This manual is copyrighted. All rights are reserved. This document may not, in whole or part, be copied, photocopied, reproduced, translated or reduced to any electronic medium or machine readable form without prior consent, in writing, from Everex Systems.

(c) Copyright February, 1987
Everex Systems, Inc.

Warning

WARNING: This equipment generates and uses radio frequency energy and if not installed and used in strict accordance with the manufacturer's instructions, it may cause interference to radio and television reception. It has been certified and found to comply with the limits for a Class B computing device in accordance with the specifications in Subpart J of Part 15 of FCC Rules, which are designed to provide reasonable protection against such interference in a residential installation. However, there is no guarantee that interference will not occur in a particular installation. If this equipment does cause interference to radio or television reception, which can be determined by turning the equipment off and on, the user is encouraged to try to correct the interference by one or more of the following measures:

- 1) Reorient the receiving antenna.
- 2) Reorient the computer with respect to the receiver.
- 3) Move the computer away from the receiver.
- 4) Plug the computer into a different outlet so that computer and receiver are on different branch circuits.
- 5) Ensure that card mounting screws, attachment connector screws, and ground wires are tightly secured.

If necessary, the user should consult the dealer or an experienced radio/television technician for additional suggestions. The user may find the following booklet prepared by the Federal Communications Commission helpful: "How to Identify and Resolve Radio TV Interference Problems." This booklet is available from the US Government Printing Office, Washington, DC 20402, Stock No. 004-000-00345-4 (FCC, Part 15.838 b).

Table of Contents

SECTION 1. INTRODUCTION	2
SECTION 2. GETTING STARTED	3
Physical Layout	3
Default Jumper and Switch Settings	4
Quick Installation	5
SECTION 3. SETTING UP THE MAGIC I/O	6
Setting the Switches and Jumpers	6
Using the Software to Configure the Magic I/O	9
Configuring Without the Software	11
The Serial Ports	11
The Parallel Port	18
The Real Time Clock	22
SECTION 4. INSTALLATION	24
Physical Installation	24
Testing the Magic I/O	28
APPENDIX I: THE EVERCLOCK SOFTWARE	29
APPENDIX II: PC-WRITE	31
APPENDIX III: HANDSHAKING SCHEMATIC	32

Section 1: Introduction

The Everex Magic I/O is the most versatile multifunction I/O card you can buy. With a parallel printer port, two serial ports (one standard and one optional) and a real time clock, the Magic I/O packs more features and connectors on a true 5" short card than most full-length multifunction cards. Additionally, all of the functions of the Magic I/O are fully configurable; you can easily select interrupts, LPT ports, COM ports and other values to best customize the Magic I/O to operate in any IBM-compatible system. This flexibility is your guarantee that the Magic I/O will work in more systems, with more combinations of hardware and software, than any other I/O card on the market.

To complement its many features the Magic I/O comes with a menu-driven diagnostics/set-up utility program *EV170* which will guide you through the configuration of your board and will test the board once it is installed.

This manual will provide you with all of the information that you need to install and use your Magic I/O. First time users should read "Section 3: Setting Up the Magic I/O" and "Section 4: Installation;" these two chapters will help you configure and install the board. "Section 2: Getting Started" is provided for experienced users who want to get the Magic I/O up and running quickly; this section provides a brief outline of the installation procedures.

Section 2: Getting Started

This chapter contains a brief description on how to install the Magic I/O. If multifunction cards are new to you, we suggest using the more comprehensive instructions in *Section 4. Installation.*

Physical Layout

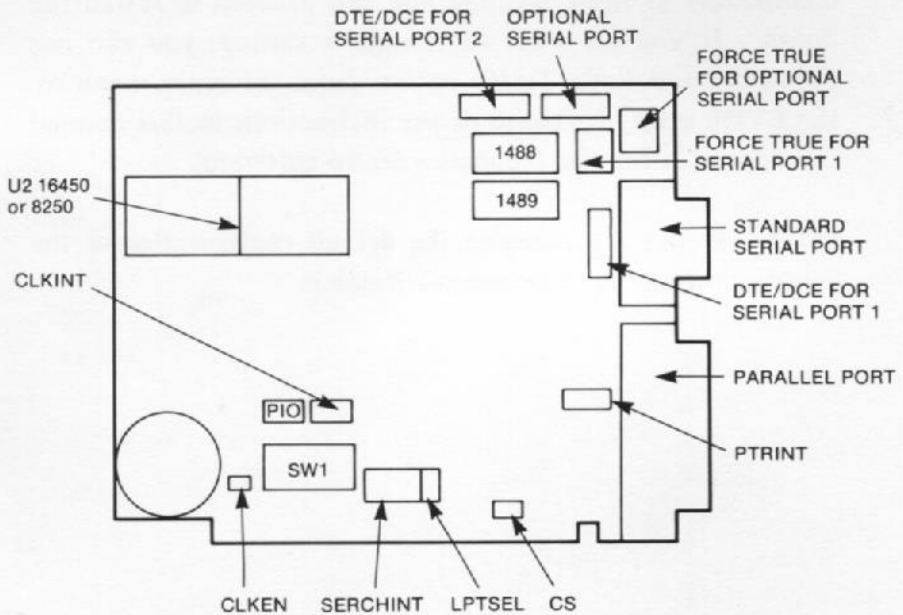

Figure 1: Magic I/O Jumpers and Switches

You communicate with the Magic I/O through the board's configuration. Each time a jumper or switch is changed, a different bit of information is conveyed to the Magic I/O.

Default Jumper and Switch Setting

The Magic I/O leaves the factory with the parallel port enabled in the printer mode and set as LPT2 at IRQ 7. LPT2 uses I/O port address 378-37F (HEX). The 9-pin serial port is enabled and set as COM 1 at IRQ 4, and as a DTE device with no force-trues. If the optional serial port is enabled, its default setting is COM 2 at IRQ 3, and it is set as a DTE device with no force-trues. If you do not want to change any of these settings, you can proceed to install the board. If you do want to change a setting, you can use either the *Installation Set Up* option from the main menu of the EVI70 utility software or the instructions in this manual (we suggest using the *Installation Set Up* software).

NOTE: If you are changing the default configuration of the board, you must do so before you install it.

Quick Installation

1. First, decide how you are going to configure each port, and set the switches and jumpers on the Magic I/O to correspond with these choices. (This can be accomplished in two ways: use the Installation Set Up option from the main menu of utility program called **EV170** that accompanies the Magic I/O or, use the tables in the "Configuring Without The Software" section of the "Installation" chapter. We highly recommend using the software.)
2. Install the board into your system, and boot-up your computer with DOS.
3. Test the Magic I/O with the software utility programs that accompany the Magic I/O. To access these programs, insert the Magic I/O utility diskette into the floppy drive and type **EV170 [Enter]**. First choose the *Installation Set Up* option and inform the software of the Magic I/O's configuration. After the configuration program is through, choose the *Test Chip Functions* option.
4. Replace the system's cover.
5. Congratulations. You have completed the installation procedures, and your system is ready for use.

Section 3: Setting Up the Magic I/O

If you are changing the default settings of the Magic I/O you must do so before the Magic I/O can be installed into your system. The only reason you change the default setup of the board is to avoid hardware conflicts in your system. Please follow the next 6 sub-sections in order to make configuring the Magic I/O as easy as possible. The software program **EV170.EXE** on the utility diskette will also help you to configure the board.

Setting the Switches and Jumpers

The Magic I/O comes from the factory with the parallel port enabled in the printer mode with port addresses from 378 to 37F and the interrupt at IRQ7. The 9-pin serial port is enabled and set as COM1 at IRQ4 and as a DTE device with no force-trues. The optional 10-pin serial port 2 is set as COM2 at IRQ3 and as a DTE device with no force trues.

You communicate with the Magic I/O through its jumpers and switches. Each time that a jumper or switch is changed, a different bit of information is conveyed to the board. The following figure is a diagram of the Magic I/O. All of the switches and jumpers are pointed out.

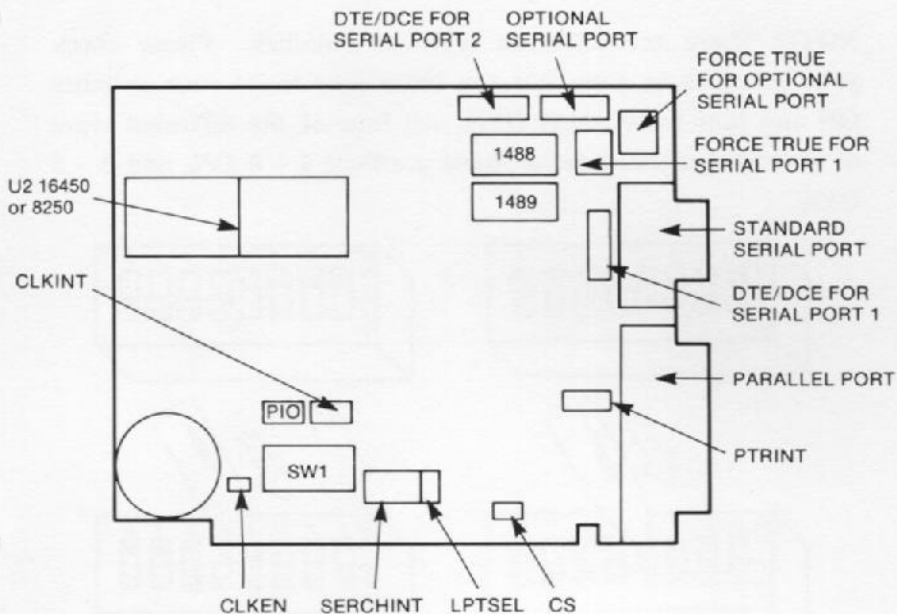

Figure 2: The Magic I/O

If you have not already done so, remove the Magic I/O from its box. Locate all of the key areas which are pointed out in this figure.

NOTE: There are different types of switches. Please check your board to be sure that you know how to set your switches ON and how to set them OFF. All four of the different types of switches pictured below have positions 1 - 4 ON, and 5 - 8 OFF.

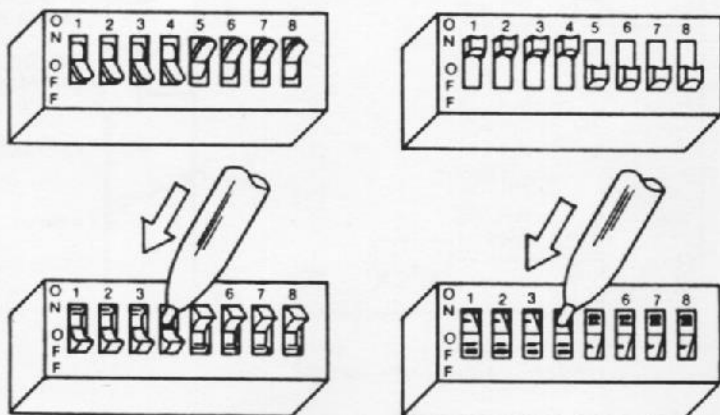

Figure 3: The Different Types Of Switches

An *Installation Set Up* program is included on the Magic I/O Utility diskette which will simplify the configuration procedures. For those of you who choose not to use this program, information is provided in this manual. (We strongly advise using the software program.) Please read on to see what you need to consider when setting up your board. To access the software, type **EV170** and the [ENTER] key.

If you will not be using the software *Installation Set Up* option, please skip to the section called *Configuring Without The Software*.

Using The Software To Configure The Magic I/O

This section describes how to access and use the *Installation Set Up* option to configure your Magic I/O.

1. Boot up your computer with DOS, and insert the Magic I/O Utility diskette into floppy disk drive A.
2. At the A> prompt type:

EV170 [ENTER]

Note: To choose an option, use the arrow keys to move the highlighted area to the option you desire, then hit the [Enter] key to activate your choice.

The utility main menu will appear on the screen. Since you are concerned with installing your Magic I/O, choose the *Installation Set Up* option.

3. To make configuring the board easy, have the board in front of you as you go through the *Installation Set Up* program.

-
4. The software will prompt you to choose which adjustments you wish to make. Make your selections on the screen.

After the software has asked you all pertinent questions, the screen will display a picture of the Magic I/O and will show you what you need to set. Physically set the switches/jumpers on your board to correspond with those "set" on the screen. The picture on the screen points out the correct jumper settings that will communicate the configurations you indicated to the Magic I/O.

You can now skip the next section.

Configuring Without The Software

Although we recommend using the *Installation Set Up* software to configure the Magic I/O, it is possible to change the jumper and switch settings with the information in this section.





















The Serial Ports

Assigning COM Ports

The dipswitch SW1 on the Magic I/O selects the COM ports for the serial ports. The factory default setting is COM 1 for Serial Port 1 and COM 2 for Serial Port 2. Both serial ports share the 8 position SW1 dipswitch.

Use the following tables(s) if you wish to change the default configuration of the serial port(s).

TABLE 1A
Com Port Switch Settings
For Serial Port 1 (SW1)

COM	POSITION			
	1	2	3	4
1*				
2				
3				
4				
DISABLED				

*Default Setting























ON—PUSH SWITCH UP



OFF—PUSH SWITCH DOWN

TABLE 1B
Com Port Switch Settings
For Serial Port 2 (SW1)

COM	POSITION			
	5	6	7	8
1				
2*				
3				
4				
DISABLED				

*Default Setting  ON—PUSH SWITCH UP  OFF—PUSH SWITCH DOWN

The I/O port addresses of the COM Ports are fixed. Table 1C lists the I/O Port Addresses of COM Ports 1 through 4.

TABLE 1C
COM Port I/O Port Addresses

COM PORT	I/O PORT ADDRESSES
1	3F8 - 3FF
2	2F8 - 2FF
3	3E8 - 3EF
4	2E8 - 2EF

Do NOT assign two serial ports to the same COM port.

Assigning Serial Port Interrupts

In order for a peripheral device to inform the computer that it is ready for instructions, it signals the computer using interrupts (IRQ). IRQ is the acronym for **I**nterrupt **R**e**Q**uest line. IBM Personal Computers have 8 levels of hardware interrupts:

Interrupt 0	=	timer
Interrupt 1	=	keyboard
Interrupt 2*	=	reserved
Interrupt 3	=	COM 2
Interrupt 4	=	COM 1
Interrupt 5	=	fixed drive
Interrupt 6	=	floppy drive
Interrupt 7	=	printer

Each serial port in your system also requires an interrupt level. The serial port interrupts are selected by the jumpers at location **SERCHINT** (**S**erial **C**hannel **I**nterrupt). Generally, COM Port 1 uses interrupt 4 while COM Port 2 uses interrupt 3. Many software programs support COM Ports 3 and 4 which share the same interrupt levels as COM Ports 1 and 2; COM Port 3 uses interrupt 4 and COM Port 4 uses interrupt 3.

*When the EV-170A is installed in an IBM AT or compatible system, IRQ 2 becomes IRQ 9.

Use the following table to select your serial port interrupt.

TABLE 2
Interrupt Jumper Settings
For the Serial Port (SERCHINT)

	SERIAL PORT 1	SERIAL PORT 2																																
IRQ2	<table border="1"> <tr><td>■</td><td>■</td><td>■</td><td>■</td></tr> <tr><td>■</td><td>■</td><td>■</td><td>■</td></tr> <tr><td>■</td><td>■</td><td>■</td><td>■</td></tr> <tr><td>■</td><td>■</td><td>■</td><td>■</td></tr> </table>	■	■	■	■	■	■	■	■	■	■	■	■	■	■	■	■	<table border="1"> <tr><td>■</td><td>■</td><td>■</td><td>■</td></tr> <tr><td>■</td><td>■</td><td>■</td><td>■</td></tr> <tr><td>■</td><td>■</td><td>■</td><td>■</td></tr> <tr><td>■</td><td>■</td><td>■</td><td>■</td></tr> </table>	■	■	■	■	■	■	■	■	■	■	■	■	■	■	■	■
■	■	■	■																															
■	■	■	■																															
■	■	■	■																															
■	■	■	■																															
■	■	■	■																															
■	■	■	■																															
■	■	■	■																															
■	■	■	■																															
IRQ3	<table border="1"> <tr><td>■</td><td>■</td><td>■</td><td>■</td></tr> <tr><td>■</td><td>■</td><td>■</td><td>■</td></tr> <tr><td>■</td><td>■</td><td>■</td><td>■</td></tr> <tr><td>■</td><td>■</td><td>■</td><td>■</td></tr> </table>	■	■	■	■	■	■	■	■	■	■	■	■	■	■	■	■	<table border="1"> <tr><td>■</td><td>■</td><td>■</td><td>■</td></tr> <tr><td>■</td><td>■</td><td>■</td><td>■</td></tr> <tr><td>■</td><td>■</td><td>■</td><td>■</td></tr> <tr><td>■</td><td>■</td><td>■</td><td>■</td></tr> </table>	■	■	■	■	■	■	■	■	■	■	■	■	■	■	■	■
■	■	■	■																															
■	■	■	■																															
■	■	■	■																															
■	■	■	■																															
■	■	■	■																															
■	■	■	■																															
■	■	■	■																															
■	■	■	■																															
IRQ4	<table border="1"> <tr><td>■</td><td>■</td><td>■</td><td>■</td></tr> <tr><td>■</td><td>■</td><td>■</td><td>■</td></tr> <tr><td>■</td><td>■</td><td>■</td><td>■</td></tr> <tr><td>■</td><td>■</td><td>■</td><td>■</td></tr> </table>	■	■	■	■	■	■	■	■	■	■	■	■	■	■	■	■	<table border="1"> <tr><td>■</td><td>■</td><td>■</td><td>■</td></tr> <tr><td>■</td><td>■</td><td>■</td><td>■</td></tr> <tr><td>■</td><td>■</td><td>■</td><td>■</td></tr> <tr><td>■</td><td>■</td><td>■</td><td>■</td></tr> </table>	■	■	■	■	■	■	■	■	■	■	■	■	■	■	■	■
■	■	■	■																															
■	■	■	■																															
■	■	■	■																															
■	■	■	■																															
■	■	■	■																															
■	■	■	■																															
■	■	■	■																															
■	■	■	■																															
IRQ5	<table border="1"> <tr><td>■</td><td>■</td><td>■</td><td>■</td></tr> <tr><td>■</td><td>■</td><td>■</td><td>■</td></tr> <tr><td>■</td><td>■</td><td>■</td><td>■</td></tr> <tr><td>■</td><td>■</td><td>■</td><td>■</td></tr> </table>	■	■	■	■	■	■	■	■	■	■	■	■	■	■	■	■	<table border="1"> <tr><td>■</td><td>■</td><td>■</td><td>■</td></tr> <tr><td>■</td><td>■</td><td>■</td><td>■</td></tr> <tr><td>■</td><td>■</td><td>■</td><td>■</td></tr> <tr><td>■</td><td>■</td><td>■</td><td>■</td></tr> </table>	■	■	■	■	■	■	■	■	■	■	■	■	■	■	■	■
■	■	■	■																															
■	■	■	■																															
■	■	■	■																															
■	■	■	■																															
■	■	■	■																															
■	■	■	■																															
■	■	■	■																															
■	■	■	■																															

*Default Setting

Note: To disable the IRQ, do not use any jumpers.

The Serial Ports As DTE or DCE:

A communication device can either be **Data Terminal Equipment (DTE)** or **Data Communication Equipment (DCE)**. In order for two communication devices to communicate, an exchange of control signals must occur. The control signals are carried through the interface (or connection) of the DTE connector and the DCE connector. The arrangement of the control signals is predetermined and will vary depending on whether the device is DTE or DCE. The exchanging of control signals between the DTE device and the DCE device is called *handshaking*.

For the serial ports there are two blocks of DCE/DTE jumpers on the Magic I/O labeled SCH1 (for Serial Port 1) and SCH2 (for Serial Port 2). In the factory default DTE setting, all six shunts are connecting both rows of pins. To set the serial port for DCE, change the connections of the shunts to form three pairs of connects per row, as shown below. This drawing applies for both sets of jumpers.

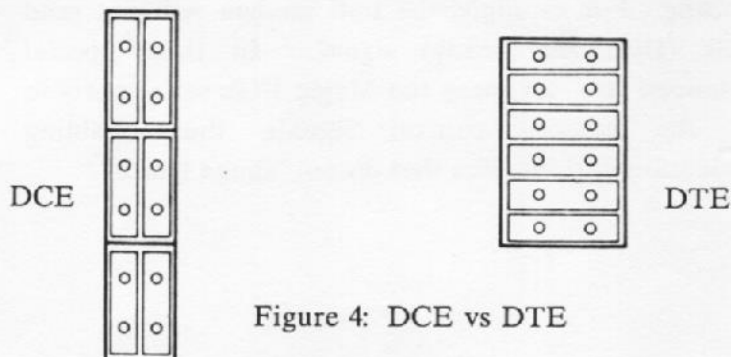

Figure 4: DCE vs DTE

Most serial devices are DCE devices which require the Magic I/O's serial ports to be set as DTE to enable communication. Since there are exceptions, you should determine if your serial device is DCE or DTE and set the Magic I/O accordingly (refer to the manual of your serial device for this information).

If a serial device attached to the Magic I/O is not working, make sure that all the other jumper and dipswitch settings pertinent to the serial port are set correctly. If you cannot determine whether your serial device is DCE or DTE and the serial device is not working with the default DTE setting, try changing the setting to DCE.

Force-trues

Most of the devices that you can attach to a serial port will do their part in the handshaking process and will send the required control signals. However, certain devices do not provide some or all of the required functions for handshaking. For example, the null modem will not send the DSR (Data Set Ready) signal. In these special circumstances, you can force the Magic I/O's serial ports to provide the missing control signals, thus enabling communication with devices that do not "shake hands."

There are four possible force-trues for the serial ports: DSR for Data Set Ready, CTS for Clear To Send, DCD for Data Carrier Detected, and RI for Ring Indicator. Check your software's manual to see which force-true you will need to enable.

The jumper block to enable force-trues is called CH1 (for serial port 1) and CH2 (for Serial Port 2). For each three-pin row, the shunt connecting the left and center pins disables force-trues, while moving the shunt to the right and center pins enables force-trues. Refer to the following figure.

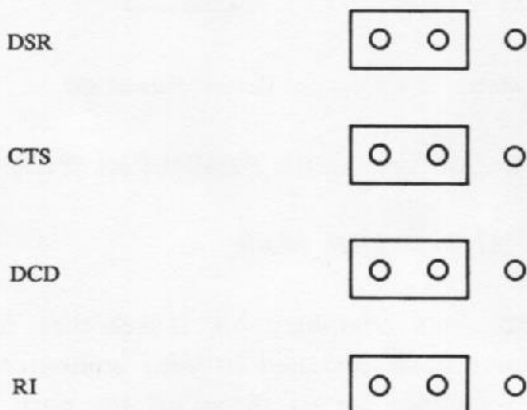

Figure 5: Setting No Force-Trues

If you need to enable any force-true signals, be careful to use the jumpers that correspond to the correct serial port. For example, do not move all the force-true shunts for Serial Port 1 and then connect your null modem to Serial Port 2.

The Parallel Port

The Magic I/O's parallel port is configured at the factory as a printer port. PIO is a 3-pin connector that selects whether the parallel port will be in the printer mode (default configuration) or a bi-directional general purpose I/O port. You do not need to change this setting if you would like the parallel port to remain in printer mode, however, if you want to change the port to a general purpose I/O port, configure it according to the following figure.

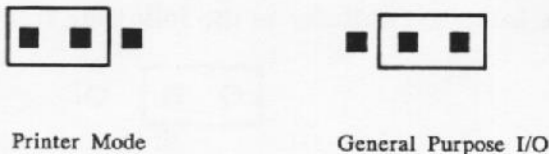

Figure 6: Configuring the Parallel Port (PIO)



The Parallel Port in Printer Mode

When you turn your computer on, it searches for the number of printer ports installed in your computer. The computer can recognize up to three printer ports. The computer follows a priority for these ports and refers to them as LPT1, LPT2, and LPT3. The I/O port address 3BC-3BF is the highest priority printer address so it is logically known as LPT1 or PRN. The lowest priority address is 278-27F so it is logically known as LPT3. The Magic I/O leaves the factory configured as LPT2 with a port address from 378-37F.

If there is only one parallel port in your system, it is referred to as LPT1 regardless of the I/O port address where it resides. However, if there are several parallel ports, the LPT's are assigned according to the priority of the port address. According to IBM's conventions, the I/O port address 3BC-3BF is the highest priority printer address and it is known as LPT1 or PRN. The IBM Monochrome Display Adapter and most compatibles have a built-in printer port configured as LPT1 with the port address 3BC-3BF. Therefore, to avoid conflicts with most monochrome display adapters, the Magic I/O printer port is configured as LPT2 with the port address 378-37F. It is possible to change the I/O port address of the Magic I/O to LPT1 or LPT3 if the address 378-37F conflicts with another parallel device in your computer. If you have a graphics adapter with a parallel port configured with a port address starting at 3BC, confirm that the port address of the Magic I/O is 378 or 278.

The parallel port on the Magic I/O is set at the factory with a port address from 378 to 37F. The default interrupt is 7. Refer to the following tables to confirm or change these settings to avoid possible hardware conflicts.

TABLE 3
Interrupt Setting For the Parallel Port (PRINT)

IRQ	PTRINT
5	
7*	

*Default Setting

Now, you should set the port address of the parallel port and the LPT name (the logical designation). This is done by adjusting the jumpers on LPTSEL as shown in the following table.

TABLE 4
LPT Jumper Settings (LPTSEL)

LPT	PORT ADDRESS	LPTSEL SETTING
*LPT 2	378-37F	<input checked="" type="checkbox"/> <input checked="" type="checkbox"/> <input type="checkbox"/> <input type="checkbox"/> <input type="checkbox"/> <input type="checkbox"/> <input type="checkbox"/> <input type="checkbox"/>
LPT 3	278-27F	<input type="checkbox"/> <input type="checkbox"/> <input type="checkbox"/> <input type="checkbox"/> <input checked="" type="checkbox"/> <input checked="" type="checkbox"/> <input type="checkbox"/> <input type="checkbox"/>
LPT 1	3BC-3BF	<input type="checkbox"/> <input type="checkbox"/> <input type="checkbox"/> <input type="checkbox"/> <input type="checkbox"/> <input type="checkbox"/> <input checked="" type="checkbox"/> <input checked="" type="checkbox"/>
DISABLED	N/A	<input type="checkbox"/> <input type="checkbox"/> <input type="checkbox"/> <input type="checkbox"/> <input type="checkbox"/> <input type="checkbox"/> <input type="checkbox"/> <input type="checkbox"/> <input type="checkbox"/> <input checked="" type="checkbox"/> <input type="checkbox"/>

*Default Setting

NOTE: Every parallel port in your computer must have its own I/O port address! In our references to the parallel port designation, we refer to the parallel port at I/O address 3BC as LPT1, the port address at 378 as LPT2, and the port address at 278 as LPT3.

The Real Time Clock

NOTE: IF YOU HAVE AN EV-170A.... Since an AT system already has a real time clock, the Magic I/O (EV-170A) does not have the clock circuit on board. Therefore, you can skip this section.

The clock/calendar is enabled at the two-pin jumper CLKEN (Clock Enable). If you are going to install the Magic I/O in a machine that already has a clock/calendar (the IBM AT and most compatibles are in this category), you can disable the Magic I/O's clock/calendar by removing the black plastic shunt from the CLKEN jumper. If you do remove the shunt, put it back over one pin for safekeeping.

The clock/calendar interrupt can be enabled by setting the CLKINT (Clock Interrupt) jumper. The default clock/calendar interrupt setting is the disable position. Table 5 gives you the possible interrupt levels of the clock/calendar and the CLKINT settings for each.

TABLE 5
Magic I/O CLKINT Jumper Settings

INTERRUPT	CLKINT SETTING
IRQ 2	<input checked="" type="checkbox"/> <input type="checkbox"/> <input type="checkbox"/>
IRQ 5	<input type="checkbox"/> <input checked="" type="checkbox"/> <input type="checkbox"/>
IRQ 7	<input type="checkbox"/> <input type="checkbox"/> <input checked="" type="checkbox"/>
*DISABLE	<input type="checkbox"/> <input type="checkbox"/> <input checked="" type="checkbox"/>

*Default Setting

Changing the Port Address of the Real Time Clock

The default I/O port address of the real time clock is 2C0-2DF. If this I/O port address conflicts with another device in your computer, you can use the Everex Clock/Calendar Upgrade Kit to change the I/O port address to 340-35F. If you do change the address to 340-35F, use the software on the Everex Systems utility diskette called SCLOCK1EXE and EVECLOCK1EXE (use these two programs instead of the software called SCLOCK and EVECLOCK).

The following figure points out the location of the IC chip that you need to replace to enable I/O address 340-35F.

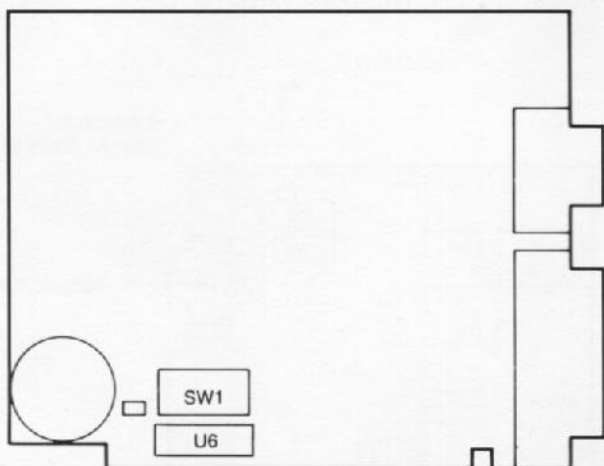

Figure 7: Replacing the Clock/Calendar IC Chip

Section 4: Installation

Physical Installation

Once the jumpers and switches have been set, you can install the board into your computer.

1. If you will not be using the optional 25 pin serial port, skip to step #2. If you will be using the optional 25 pin serial port, you will need to make the following adjustments before continuing.
 - a. When you order an optional serial port, you receive a special ribbon cable with a ten-pin female connector at one end and a 25-pin male connector at the other end. The optional serial port is the 10-pin connector at J3 in the upper right corner of the Magic I/O. Connect the ten-pin end of the cable to J3 as shown in the following figure.

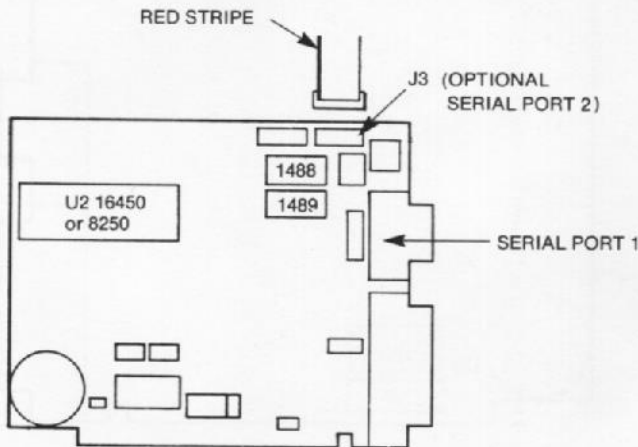

Figure 8: Optional Serial Port Connector and Chip Location

-
- b. In addition to the special cable, three IC chips are required to implement the second serial port. These chips are labeled:

1. 16450 (for the AT) or 8250 (for the PC or XT)
2. 1488
3. 1489

Please refer to the Figure 7 on the previous page for the location of each of these chips. The chips have a pin 1 which is marked with a notch or a dot (refer to the figure below).

If you look carefully at the Magic I/O board, each chip socket has the outline of a notched chip in the proper orientation. Be sure to insert the chip following this orientation. To install the chips, insert the tips of the pins into the holes in the socket. Make sure the alignment is exactly right, then press the chip into place.

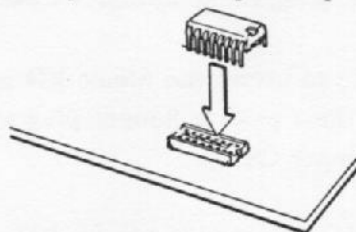

Figure 9: Installing an IC Chip

NOTE: The connectors that correspond to each serial port are permanently assigned and cannot be reversed.

-
2. Turn OFF the power to your computer, and remove the cover of your system. **Make sure there is no power going to your system!**
 3. Choose any expansion slot on the mother board.
 4. Remove the **expansion slot cover** from the back of the chosen expansion slot. To do this, you will need to unscrew the screw which holds the metal cover in place. You should save the screw, as you can use it to secure the Magic I/O into place.

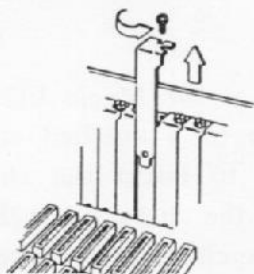

Figure 10: Removing The Slot Cover

NOTE: If you are going to install the Magic I/O into short slot 8 of the IBM XT, you must place a jumper plug over both pins of the System Select jumper CS.

5. Gently, but firmly, insert the Magic I/O card all the way into the expansion slot. Make sure the gold connecting fingers snap all the way into place. Refer to the next figure.

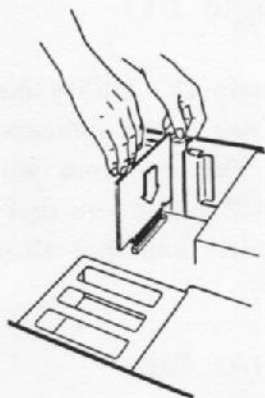

Figure 11: Installing the Magic I/O

6. Use the screw which you removed from the expansion slot cover to secure the Magic I/O in place.
7. If you will be using the parallel port or either serial port, you should plug the appropriate device into the appropriate port (connector).
8. Replace the cover to your system and any cords or cables you disconnected earlier.
9. Boot up your system from DOS.
10. Test the Magic I/O with the software programs on the utility diskette. Type **EV170** and press the [enter] key. First choose the *Installation Set Up* option and inform the software about how your board is configured. Then return to the main menu and choose the *Test Chip Functions* option.

Testing the Magic I/O

Included in your Magic I/O Utility diskette is a program which will check to see if the jumpers and switches have been set properly. This program will only take a few minutes to run and will assure you that the installation has been performed properly and that all of the chips on the Magic I/O are good.

To Run the Magic I/O Test:

1. Boot your system with DOS. Insert the Magic I/O utility diskette into drive A and type at the A> prompt:

EV170 [ENTER]

2. The Magic I/O's main menu will appear on the screen. Choose the *Installation Set Up* option and go through the utility to inform the program how the Magic I/O is configured.
3. After you have told the program how the Magic I/O is setup, return to the main menu and choose the *TestChip Functions* option. Go through each Chip Test. The chips will be tested sequentially. The chips under evaluation will blink in the diagram on your screen until they have been tested and their status is displayed on the screen.

Congratulations! You have completed your installation. Reinsert the cover of your computer, and it will be ready for use.

Appendix I: The Everclock Software

Your PC, XT or compatible system requires special software, EVECLOCK, in order to recognize and use its clock/calendar. To install this program onto your system:

1. Use the DOS commands TIME and DATE to set the correct time and date in your system. Remember to use 24-hour military time in setting the clock (for example, 3:30 pm equals 15:30 in 24-hour time).

NOTE For Users With the Clock/Calendar Upgrade Kit:

If you changed the port address of the clock/calendar to 340-35F, use the software called SCLOCK1 and EVECLOCK1 instead of the software mentioned in this appendix.

2. Insert the Magic I/O utility diskette in drive A. At the A> prompt, type:

SCLOCK [ENTER]

This program stores the correct time and date from your system (DOS) into the Magic I/O's clock chip.

3. Copy the program EVECLOCK.COM from the Magic I/O utility diskette into the root directory of your system disk.

-
4. Once the correct time and date have been stored by your Magic I/O, they will be automatically kept and updated even when your computer is turned off. However, in order for the system (DOS) to stay current, it must read the time and date from the Magic I/O each time you boot up. If an AUTOEXEC.BAT is present in your root directory, it will be executed whenever the system is booted up. Therefore, by placing the EVECLOCK.COM program in your AUTOEXEC.BAT file this is accomplished for you automatically.

If you already have an AUTOEXEC.BAT file present on your system disk, add the line **eveclock** to this file. If you do not already have such a file, create one in your root directory that contains the following lines:

```
COPY CON AUTOEXEC.BAT [ENTER]  
EVECLOCK [ENTER]
```

Press the **[F6]** function key and the **[enter]** key to save your autoexec.bat file.

5. The commands in the autoexec.bat file will be executed each time you boot up. To start the Everclock software, re-boot your system.

Appendix II: PC-Write

Included with your Magic I/O is a word processing program called PC-Write. The manual for PC WRITE is on your utility diskette. If you wish to use this utility, you should type:

TYPE READ.ME

Appendix III: Handshaking Schematic

The following portion of the Magic I/O's schematic diagram details the handshaking functions performed by the DTE/DCE and force-true jumpers.

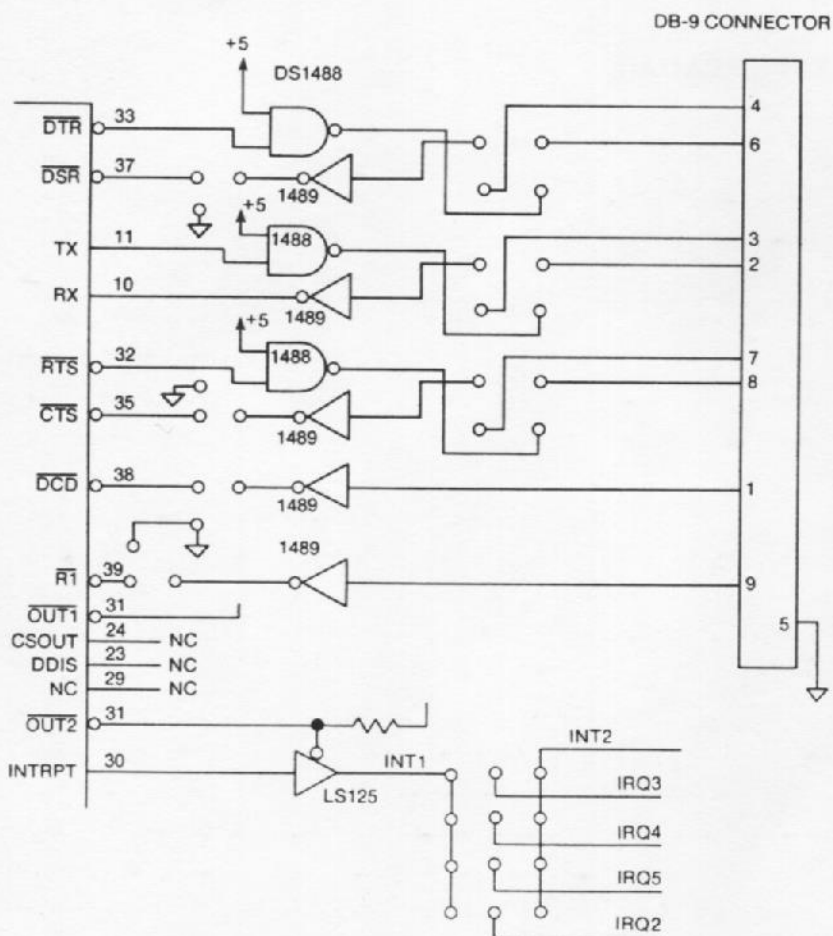

**EVEREX SYSTEMS INC.
48431 MILMONT DRIVE
FREMONT, CA 94538**

**SALES: (415) 683-2100
TECH SUPPORT: (415) 498-1115
FAX: (415) 651-0728
TELEX: 5101000590**

MAN-00054-40